



Extend Your Security into Multi-dimension

- Dahua Industry Drone

DRONE & CONTROLLER



X650

Diagonal wheelbase: 666 mm
Endurance: 25 mins
Operating radius: 3~5 km
(Differs in different environments)
Max. take-off weight: 6.3 kg
Max. wind resistance: 15 m/s
Working environment: -20~60°C
<95% RH

Smart battery



X820

Diagonal wheelbase: 940 mm
Endurance: 45 mins
Operating radius: 3~10 km
(Differs in different environments)
Max. take-off weight: 10.0 kg
Max. wind resistance: 15 m/s
Working environment: -20~60°C
<95% RH

Smart battery



Coming Soon

X1100

Diagonal wheelbase: 1100 mm
Endurance: 41 mins
Operating radius: 3~10 km
(Differs in different environments)
Max. take-off weight: 14.5 kg
Max. wind resistance: 15 m/s
Working environment: -20~60°C
<95% RH

Smart battery



X1550

Diagonal wheelbase: 1550 mm
Endurance: 60 mins
Operating radius: 3~10 km
(Differs in different environments)
Max. take-off weight: 23.6 kg
Max. wind resistance: 15 m/s
Working environment: -20~60°C
<95% RH

Smart battery

PC Ground Station(Optional)

Bandwidth: 8Mbps
Display Screen: 13.1" touch screen
Storage: 450 GB
Onvif: Support
4G Transmission: Support



Remote Controller

Control Distance: 3~10 km
(Differs in different environments)
Display Screen: 7" touch screen
4G Transmission: Support



PAYLOAD (OPTIONAL)



2MP PTZ Camera
30x/40x Optical Zoom



4K PTZ Camera
30x Optical Zoom



Thermal Camera
720P, Support Temperature Detective



Thermal Hybrid PTZ
Thermal: 720P
Visible Light: 2MP, 30x Optical Zoom

Live Capturing Gun

2MP 3-axis PTZ
Capturing Size: 20m²



Live Lighting PTZ Camera

2MP 3-axis PTZ
Lighting Distance: ≥50m



Live Throwing

2MP 3-axis PTZ
Max. Payload Capacity: 10kg



Live Broadcasting Throwing

Integrated with
Camera Broadcasting, Throwing



Gas Detention

Number of Sensor: 6
Detection Accuracy: 0.01~50ppm

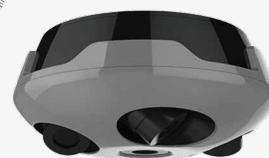

3D Camera

5 Lenses
3D Modeling

TOPOLOGY



DRONE

ACCESS 1

COMMAND CENTER

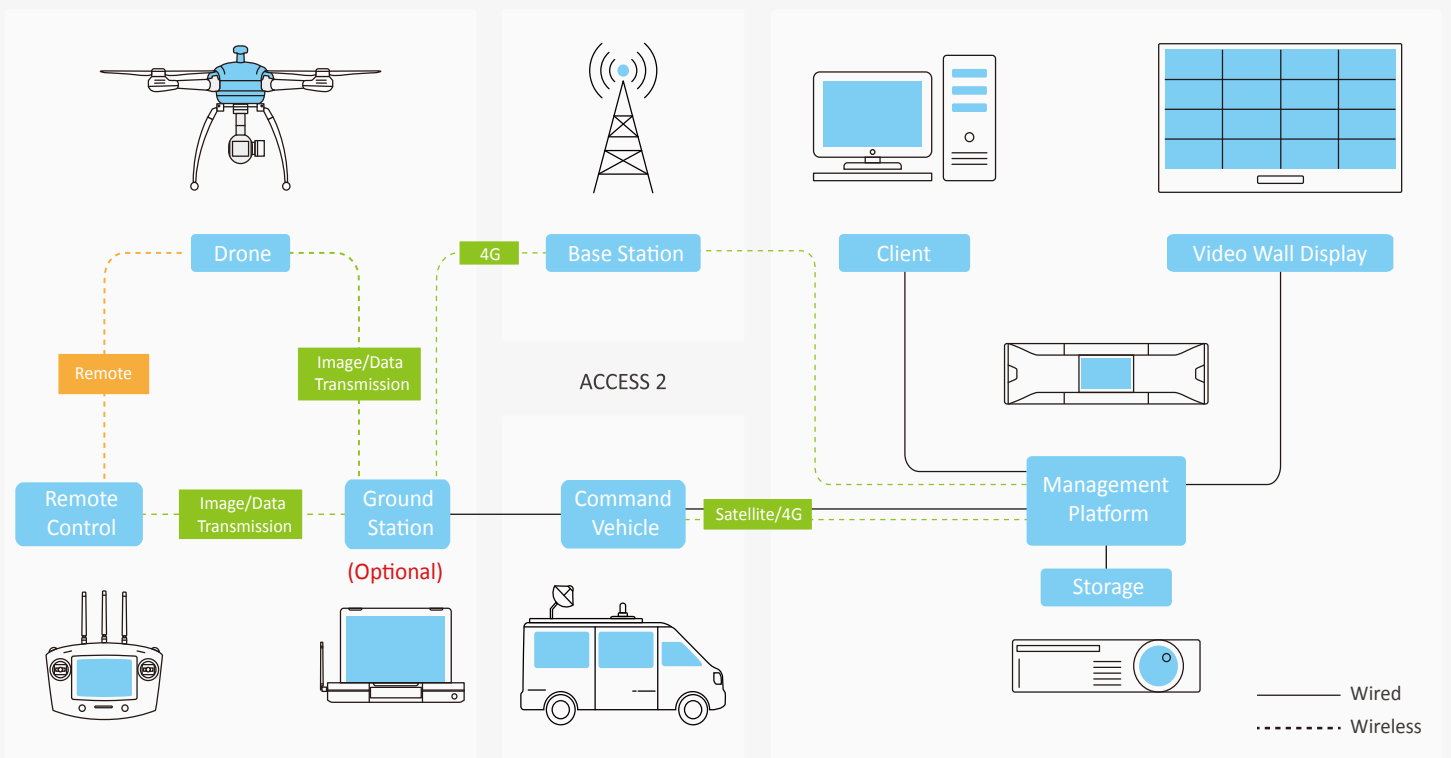
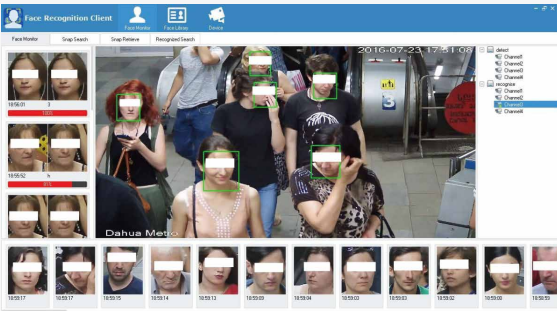



Plate Number Recognition

- > Automatic license plate recognition
- > Capture database query
- > Vehicle feature fetch
- > Feature real-time comparison
- > Batch export of captured images
- > Display of comparing results
- > Sort by similarity



Face Recognition

- > Automatic face recognition, tracking
- > Face image quality evaluation
- > Capture face database query
- > Face features fetch
- > Feature real-time comparison
- > Batch export of captured images
- > Picture comparison
- > Display of comparing results
- > Sort by similarity



3D Modeling

- > Automatic photograph
- > Automatic 3D modeling
- > GPS information on 3D model
- > Integration of 3D model in GIS map

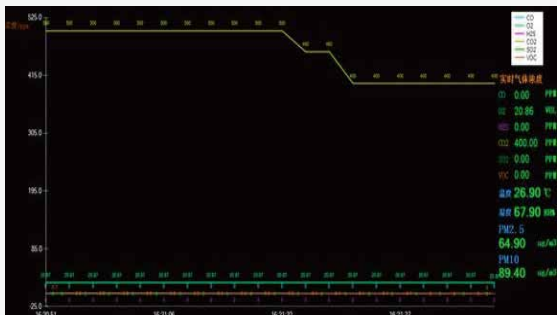

Gas Detection

- > Automatic real-time gas detection
- > Detection accuracy: 0.01~50ppm
- > CO, O₂, H₂S, HCL, SO₂, NH₃, NO, N₂O, O₃, CH₄, H₂, Cl₂, etc

SAFETY PROTECTION

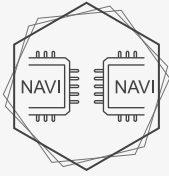

Redundant Navigation System

Adopt GPS, BEIDOU and GLONASS mode, enhance applicable scenarios.



Fault-tolerant Protection

Motor Protection, Sensor fault protection, Propeller protection.



Military-level Device

High precision sensor, wider working temperature, higher reliability.

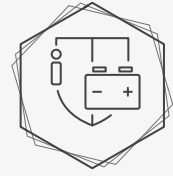

Smart Battery

Special smart battery, over charge and discharge protection, power display and anti-misoperation design.



Smart Return

Smart return when lost or low-battery, guarantee safe return during emergency.



Wireless Data Encryption

Dual-channel of Image/data transmission and remote changable, secret key, impossible to be cracked.



High-strength Composites

Adopt top carbon fibre composite, lighter and stronger.



Extreme Environment

Pass ALT, high/low temperature vibration, protection test and etc, adaptive to various complicated environments

APPLICATION



Emergency Rescue



Forest Fire Prevention



Naval Base



Energy Pipeline Patrol



Border Patrol



Traffic Detection



Power Grid Inspection



Security Protection

* Design and specifications are subject to change without notice.

Dahua Industry Drone - 01, May, 2018



DAHUA TECHNOLOGY

No.1199 Bin'an Road, Binjiang District, Hangzhou, China. 310053

Tel: +86-571-87688883 Fax: +86-571-87688815

Email: overseas@dahuatech.com

www.dahuasecurity.com

dahua
TECHNOLOGY

© Dahua Technology, All rights reserved